



ENSHINE Lighting
lights up your world for
love and hope

www.enshinelighting.com





Company Profile

Enshine lighting was established in 2006 to specialize in manufacturing LED lamps.

By 2025

● Factory Area
70,000 square meters

● Production Line
30 lines

● Daily Capacity
360,000pcs

Enshine Lighting has a mature product R&D, production, quality control, supply chain management system. From raw material, production line to finished-products, each process is inspected strictly by our conscientious and experienced QC auditors to ensure the stable quality and low cost.

We design, we R&D, we manufacture, we inspect, we consistently surpass customer expectations in quality, innovation, value and service.

Quality is not an option, it's an obligation!

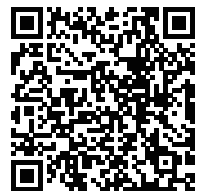

VR Visit Factory



▲ R&D Department



▲ Manufacturing Shop



▲ Injection Workshop

Transparent end cap is available



SKD Easy assemblable
Full PC

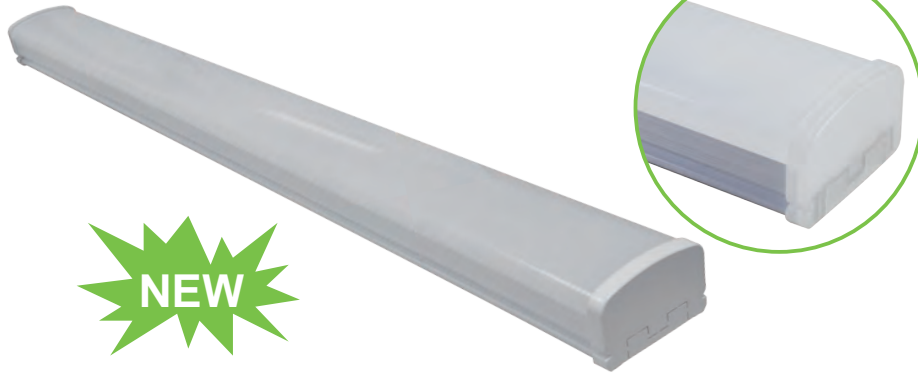
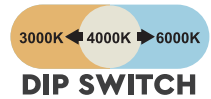

Model Number	Rated Wattage	Input Voltage	Color Temp.	Lumen(±10%)	C.R.I.	Material	Lamp Size
YX-BAN-C	20W	AC 90-265V	2700K-7000K	1800lm	>80	Full PC	300x54x40mm
YX-BAN-C	40W	AC 90-265V	2700K-7000K	3600lm	>80	Full PC	600/1200x54x40mm
YX-BAN-C	60W	AC 90-265V	2700K-7000K	5400lm	>80	Full PC	900/1200x54x40mm
YX-BAN-C	80W	AC 90-265V	2700K-7000K	7200lm	>80	Full PC	1200x54x40mm

Full PC

**Two Mounting Solutions:
Surface & Suspension**

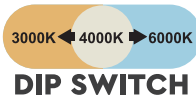
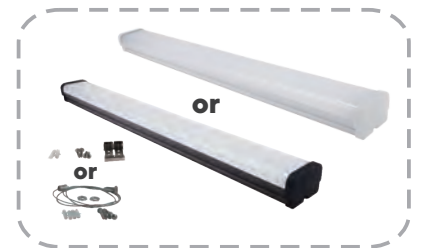

Model Number	Rated Wattage	Input Voltage	Color Temp.	Lumen(±10%)	C.R.I.	Material	Lamp Size
YX-BAN-D	20W	AC 90-265V	2700K-7000K	1800lm	>80	Full PC	600x60x40mm
YX-BAN-D	40W	AC 90-265V	2700K-7000K	3600lm	>80	Full PC	600/1200x60x40mm
YX-BAN-D	60W	AC 90-265V	2700K-7000K	5400lm	>80	Full PC	900/1200x60x40mm
YX-BAN-D	80W	AC 90-265V	2700K-7000K	7200lm	>80	Full PC	1200x60x40mm
YX-BAN-D	100W	AC 90-265V	2700K-7000K	9000lm	>80	Full PC	1200x60x40mm

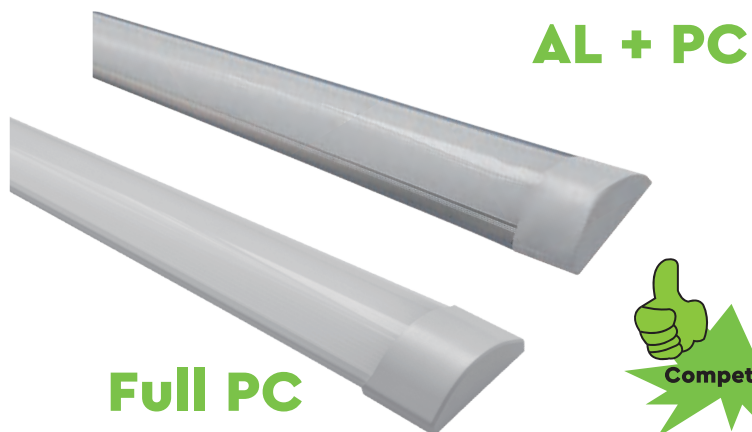

Model Number	Rated Wattage	Input Voltage	Color Temp.	Lumen(±10%)	C.R.I.	Material	Lamp Size
YX-BAN-B	20W	AC 90-265V	2700K-7000K	1800lm	>80	AL+PC	600x75x25mm
YX-BAN-B	40W	AC 90-265V	2700K-7000K	3600lm	>80	AL+PC	1200x75x25mm
YX-BAN-B	20W	AC 90-265V	2700K-7000K	1800lm	>80	Full PC	600x75x25mm
YX-BAN-B	40W	AC 90-265V	2700K-7000K	3600lm	>80	Full PC	1200x75x25mm

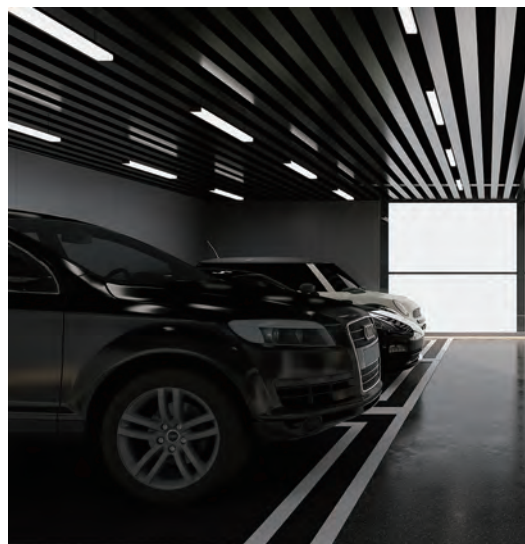
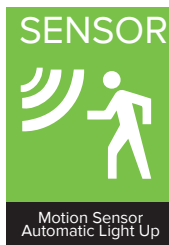

Model Number	Rated Wattage	Input Voltage	Color Temp.	Luminous Flux (±10%)	C.R.I.	IP	Width
YX-BAN-AA	9-48W	AC 90-265V	2700K-7000K	90lm/W	>80	IP20/IP44	116mm



Direct docking



Turn connection



Wire connection

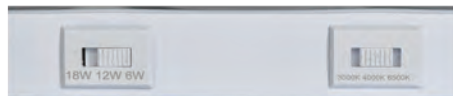

Power Selectable



DIP SWITCH

Model Number	Rated Wattage	Input Voltage	Color Temp.	Lumen(±10%)	C.R.I.	Beam Angle	Lamp Size
YX-T5	6W	AC 90-265V	2700K-7000K	540lm	>80	180°	300×23×35mm
YX-T5	12W	AC 90-265V	2700K-7000K	1080lm	>80	180°	600×23×35mm
YX-T5	18W	AC 90-265V	2700K-7000K	1600lm	>80	180°	1200×23×35mm
YX-T5	24W	AC 90-265V	2700K-7000K	2100lm	>80	180°	1500×23×35mm

Material:

- PC/NANO
- GLASS
- AL+PC



Model Number	Rated Wattage	Input Voltage	Color Temp.	Lumen(±10%)	C.R.I.	Beam Angle	Lamp Size
YX-T8	6W	AC 90-265V	2700K-7000K	540lm	>80	180°	300×29×29mm
YX-T8	12W	AC 90-265V	2700K-7000K	1080lm	>80	180°	600×29×29mm
YX-T8	18W	AC 90-265V	2700K-7000K	1600lm	>80	180°	1200×29×29mm
YX-T8	24W	AC 90-265V	2700K-7000K	2100lm	>80	180°	1500×29×29mm

NEW



- Philips driver
- Power is selectable
- High light efficacy



quality

Model Number	Rated Wattage	Input Voltage	Color Temp.	Lumious Flux (±10%)	Material	IP	C.R.I.	Lamp Size
YX-LNF03	25-44W	AC 165-265V	2700K-7000K	130lm/W	AL+PC	IP65	>80	1200x44x52mm
YX-LNF03	45-65W	AC 165-265V	2700K-7000K	130lm/W	AL+PC	IP65	>80	1200x44x52mm
YX-LNF04	25-44W	AC 90-265V	2700K-7000K	130lm/W	AL+PC	IP65	>80	1200x73x61mm
YX-LNF04	45-65W	AC 90-265V	2700K-7000K	130lm/W	AL+PC	IP65	>80	1200x73x61mm
YX-LNF05	25-44W	AC 90-265V	2700K-7000K	130lm/W	AL+PC	IP65	>80	1200x73x84mm
YX-LNF05	45-65W	AC 90-265V	2700K-7000K	130lm/W	AL+PC	IP65	>80	1200x73x84mm

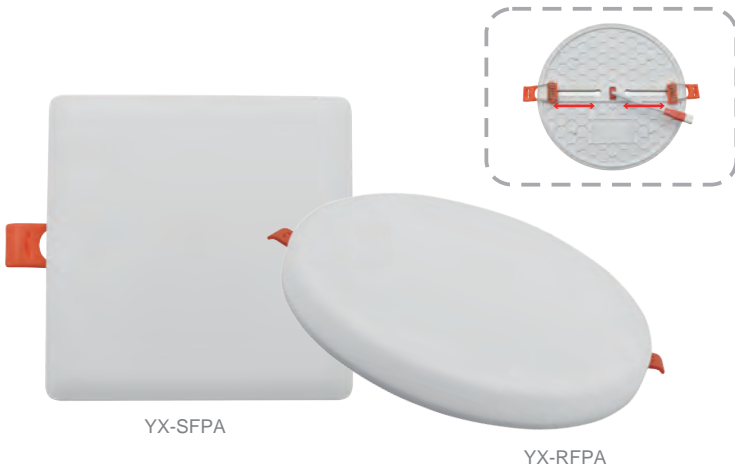

YX-SFPA

YX-RFPA



YX-SPAAS

YX-RPAAS

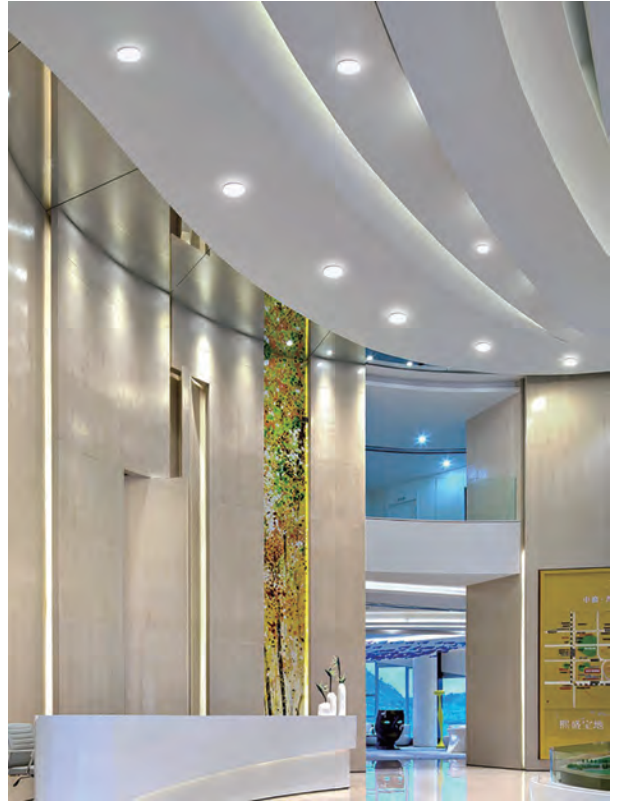

Model Number	Rated Wattage	Input Voltage	Color Temp.	Luminous flux (±10%)	C.R.I.	Hole Size	Lamp Size	Pcs/Carton	Carton Size
YX-SFPA/RFPA	10W	AC 90-265V	2700K-7000K	90lm/w	>80	Φ55-75mm	Φ100mm	100	545×440×250mm
YX-SFPA/RFPA	18W	AC 90-265V	2700K-7000K	90lm/w	>80	Φ55-95mm	Φ120mm	60	435×440×320mm
YX-SFPA/RFPA	24W	AC 90-265V	2700K-7000K	90lm/w	>80	Φ55-155mm	Φ170mm	40	380×440×410mm
YX-SFPA/RFPA	36W	AC 90-265V	2700K-7000K	90lm/w	>80	Φ55-200mm	Φ225mm	30	735×440×265mm
YX-SPAAS/RPAAS	18W	AC 90-265V	2700K-7000K	90lm/w	>80	/	Φ120×45mm	60	540×395×275mm
YX-SPAAS/RPAAS	24W	AC 90-265V	2700K-7000K	90lm/w	>80	/	Φ170×45mm	40	540×370×380mm
YX-SPAAS/RPAAS	36W	AC 90-265V	2700K-7000K	90lm/w	>80	/	Φ225×45mm	30	720×540×250mm
YX-SPAAS/RPAAS	48W	AC 90-265V	2700K-7000K	90lm/w	>80	/	Φ300×45mm	20	640×540×330mm

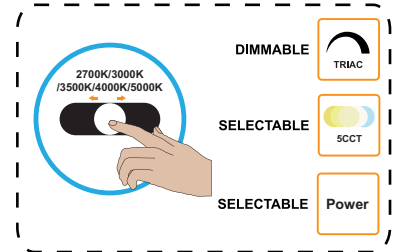

UGR: <19
Lifespan: 50,000h



Model Number	Size	Power	Input Voltage	Color Temp.	C.R.I	Luminous flux (±10%)	Pcs/Carton	Carton Size
YX-BPA	600x600mm	24W/36W/40W/ 48W/72W/96W	AC 85-265V	2700-7000K	80	100lm/W	8	650x290x650mm



YX-DLA-C

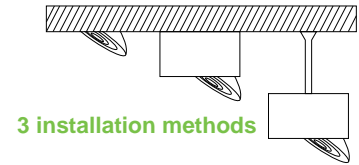

3 installation methods

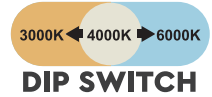

DIP SWITCH

Model Number	Rated Wattage	Input Voltage	Color Temp.	Luminous flux (±10%)	C.R.I.	Hole size	Lamp Size
YX-DLA-C	5W	AC 90-265V	2700K-7000K	80lm/W	>80	75mm	Φ95mm
YX-DLA-C	7W	AC 90-265V	2700K-7000K	80lm/W	>80	75mm	Φ95mm
YX-DLA-C	9W	AC 90-265V	2700K-7000K	80lm/W	>80	105mm	Φ125mm
YX-DLA-C	12W	AC 90-265V	2700K-7000K	80lm/W	>80	105mm	Φ125mm



YX-DLS



YX-DLC



WW 3000K NW 4000K CW 6500K

Model Number	Rated Wattage	Input Voltage	Color Temp.	Luminous flux (±10%)	C.R.I.	Hole size	Lamp Size
YX-DLC	8W	AC 90-265V	2700K-7000K	90lm/W	>80	75mm	90×73mm
YX-DLC	10W	AC 90-265V	2700K-7000K	90lm/W	>80	90mm	105×86mm
YX-DLS	5W	AC 90-265V	2700K-7000K	90lm/W	>80	70mm	92×55mm
YX-DLS	7W	AC 90-265V	2700K-7000K	90lm/W	>80	70mm	92×55mm
YX-DLS	9W	AC 90-265V	2700K-7000K	90lm/W	>80	90mm	115×60mm
YX-DLS	12W	AC 90-265V	2700K-7000K	90lm/W	>80	90mm	115×60mm

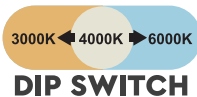

YX-BHR01

YX-BHO01



Model Number	Rated Wattage	Input Voltage	Frequency	Color Temp.	Lumen(±10%)	IP	C.R.I.	PF	Lamp Size
YX-BHR01	24W	AC 90-265V	50/60Hz	2700K-7000K	1600lm	IP54/IP65	>80	>0.5	Φ206×H50mm
YX-BHO01	24W	AC 90-265V	50/60Hz	2700K-7000K	1600lm	IP54/IP65	>80	>0.5	255×126×50mm

Full PC



YX-BHR02

YX-BHO02



Dusk to dawn

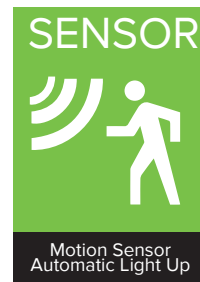

Model Number	Rated Wattage	Input Voltage	Frequency	Color Temp.	Lumen(±10%)	IP	C.R.I.	PF	Lamp Size
YX-BHR02	12W	AC 90-265V	50/60Hz	2700K-7000K	960lm	IP54/IP65	>80	>0.5	Φ160×H46mm
YX-BHR02	15W	AC 90-265V	50/60Hz	2700K-7000K	1200lm	IP54/IP65	>80	>0.5	Φ160×H46mm
YX-BHO02	12W	AC 90-265V	50/60Hz	2700K-7000K	960lm	IP54/IP65	>80	>0.5	175×84×46mm
YX-BHO02	15W	AC 90-265V	50/60Hz	2700K-7000K	1200lm	IP54/IP65	>80	>0.5	175×84×46mm

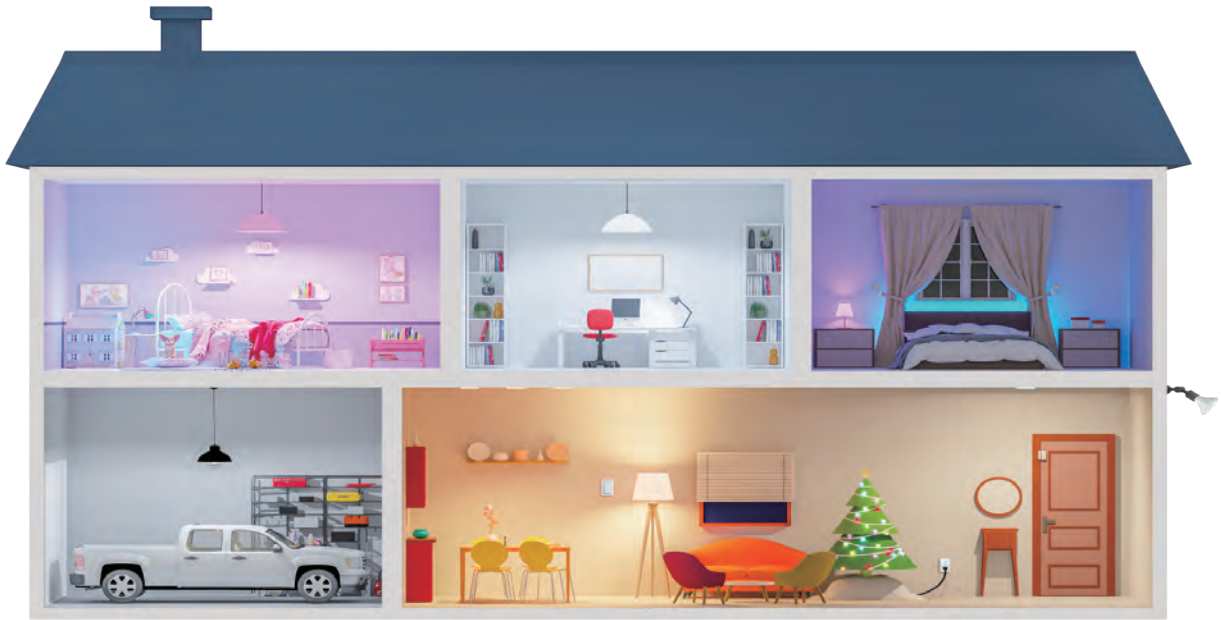

RGBCW



matter



work with the amazon alexa



work with the Google Assistant

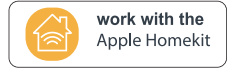

work with the Apple Homekit



work with the SmartThings



16 million colours



Remote control



Voice control



Smooth dimming



Schedule



Group control



Smart Life APP



Compatible with the Google Assistant



Compatible with alexa



Siri shortcuts



SmartThings





YX-PAR



YX-BR



YX-BU35

YX-BU31



YX-BU11



YX-CD7



YX-BU22



YX-SPC2



YX-G45BU27



YX-GX53



3-step dimming or CCT



Dimmable



Day/Night Sensor



Motion Sensor



YX-G4



YX-G9

IP65

IoADJ

Power

PHILIPS DRIVER

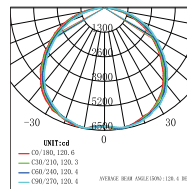
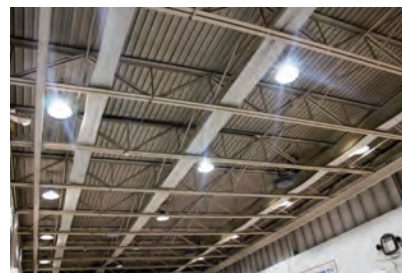

Dist. (M)	Enadir (lx)
10m	52.29
20m	13.07
30m	5.810
40m	3.268
50m	2.092

Model Number	Power	Input Voltage	Luminous flux (±10%)	Color Temp.	C.R.I.	IP	PF	Lifespan	Material	Size
YX-HL-02	100W	AC 100-277V	150-160lm/w	6000K-6500K	>70	IP65	>0.9	50,000H	Aluminum + PC	D301x120mm
YX-HL-02	150W	AC 100-277V	150-160lm/w	6000K-6500K	>70	IP65	>0.9	50,000H	Aluminum + PC	D352x120mm
YX-HL-02	200W	AC 100-277V	150-160lm/w	6000K-6500K	>70	IP65	>0.9	50,000H	Aluminum + PC	D383x120mm

IP65

IoADJ

Power

PHILIPS DRIVER

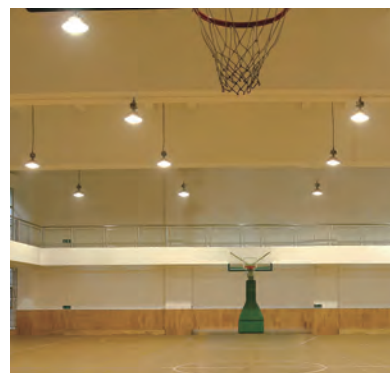

Optional Accessories



Model Number	Power	Input Voltage	Luminous flux (±10%)	Color Temp.	C.R.I.	IP	PF	Lifespan	Material	Size
YX-HL-03	100W	AC 100-277V	120-130lm/w	6000K-6500K	80	IP65	>0.9	50,000H	Aluminum + PC	D240x110mm
YX-HL-03	150W	AC 100-277V	120-130lm/w	6000K-6500K	80	IP65	>0.9	50,000H	Aluminum + PC	D280x117mm
YX-HL-03	200W	AC 100-277V	120-130lm/w	6000K-6500K	80	IP65	>0.9	50,000H	Aluminum + PC	D320x120mm

IP65

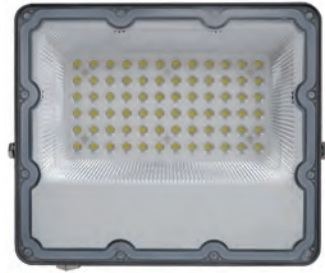

Die-casting Aluminum



Model Number	Power	Input Voltage	Luminous flux (±10%)	Color Temp.	C.R.I.	IP	Material	Size
YX-FL-01	10W	AC 100-265V	100-110lm/w	6000K-6500K	>80	IP65	Die-cast Alu+PC	127×100×25mm
YX-FL-01	20W	AC 100-265V	100-110lm/w	6000K-6500K	>80	IP65	Die-cast Alu+PC	150×128×25mm
YX-FL-01	30W	AC 100-265V	100-110lm/w	6000K-6500K	>80	IP65	Die-cast Alu+PC	161×123×25mm
YX-FL-01	50W	AC 100-265V	100-110lm/w	6000K-6500K	>80	IP65	Die-cast Alu+PC	190×170×25mm
YX-FL-01	100W	AC 100-265V	100-110lm/w	6000K-6500K	>80	IP65	Die-cast Alu+PC	230×195×25mm
YX-FL-01	150W	AC 100-265V	100-110lm/w	6000K-6500K	>80	IP65	Die-cast Alu+PC	255×206×25mm
YX-FL-01	200W	AC 100-265V	100-110lm/w	6000K-6500K	>80	IP65	Die-cast Alu+PC	255×220×25mm

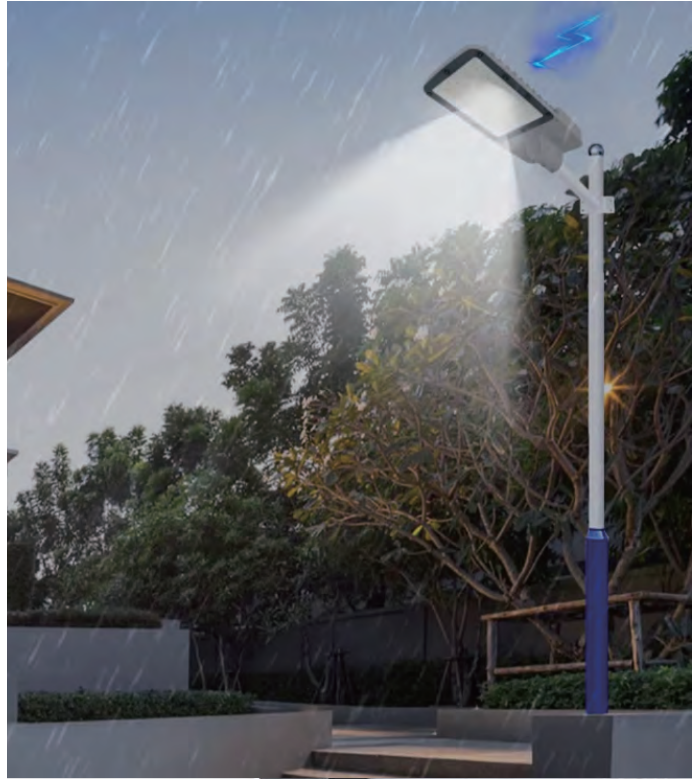
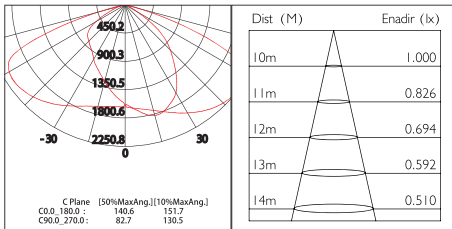

DRIVER BRAND PHILIPS

International well-known brand driver



Model Number	Power	Input Voltage	Luminous flux (±10%)	Color Temp.	C.R.I.	IK/IP	Size
YX-SL-05	100W	AC 100-277V	140-150lm/w	6000K-6500K	>70	IK08/IP65	430×310×170mm
YX-SL-05	150W	AC 100-277V	140-150lm/w	6000K-6500K	>70	IK08/IP65	430×310×170mm
YX-SL-05	200W	AC 100-277V	140-150lm/w	6000K-6500K	>70	IK08/IP65	525×310×170mm
YX-SL-05	250W	AC 100-277V	140-150lm/w	6000K-6500K	>70	IK08/IP65	525×310×170mm
YX-SL-05	300W	AC 100-277V	140-150lm/w	6000K-6500K	>70	IK08/IP65	595×310×170mm
YX-SL-05	400W	AC 100-277V	140-150lm/w	6000K-6500K	>70	IK08/IP65	595×310×170mm

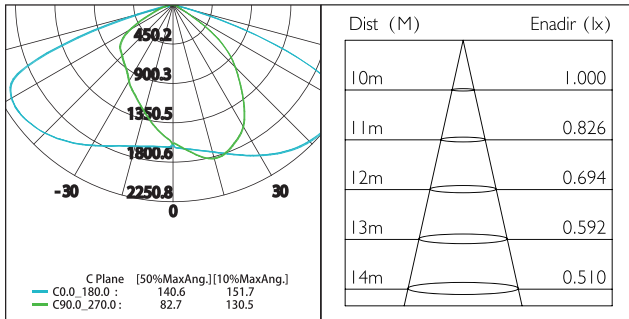

Model Number	Power	Input Voltage	Luminous flux (±10%)	Color Temp.	C.R.I.	IK/IP	Size
YX-SL-06	100W	AC 100-277V	120lm/w	6000K-6500K	>70	IK08/IP65	585x210x103mm
YX-SL-06	150W	AC 100-277V	120lm/w	6000K-6500K	>70	IK08/IP65	605x265x103mm
YX-SL-06	200W	AC 100-277V	120lm/w	6000K-6500K	>70	IK08/IP65	707x265x103mm
YX-SL-06	300W	AC 100-277V	120lm/w	6000K-6500K	>70	IK08/IP65	760x280x103mm



Model Number	Power	Input Voltage	Luminous flux (±10%)	Color Temp.	PF	IK/IP	Size
YX-SL-07	50W	AC 85-265V	90lm/w	6000K-6500K	>0.9	IK08/IP65	490×200×60mm
YX-SL-07	100W	AC 85-265V	90lm/w	6000K-6500K	>0.9	IK08/IP65	720×270×80mm
YX-SL-07	150W	AC 85-265V	90lm/w	6000K-6500K	>0.9	IK08/IP65	850×320×80mm
YX-SL-07	200W	AC 85-265V	90lm/w	6000K-6500K	>0.9	IK08/IP65	950×330×80mm

**A++
Monocrystalline Solar Panel**

IP65



Model Number	YX-FL-03-SS	YX-FL-03-SS
Power	200W	400W
Battery type	3.2V / 20000mAh LiFePO4	3.2V / 30000mAh LiFePO4
Solar panel	25W 6V Monocrystalline	45W 6V Monocrystalline
Working pattern	Light Sensor + Time Control + Remote Control	
Material	Aluminum+PC/Glass	Aluminum+PC/Glass
CCT	6500-7000K	6500-7000K
Beam Angle	90°	90°
Working time	2--3 rainy days	2--3 rainy days
Lifetime	30000H	30000H



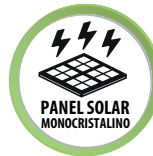

Model Number	YX-SS-02	YX-SS-02
Power	200W	400W
Battery type	LFP 32650 3.2V 20000mAh	LFP 32650 3.2V 30000mAh
Solar panel	Monocrystalline 5V 24W	Monocrystalline 5V 45W
Working pattern	light control + remote control + time control	
Beam Angle	70°* 140°	70°* 140°
Material	Die-casting aluminum+PC	Die-casting aluminum+PC
CCT	6500-7000K	6500-7000K
Warranty	3 years	3 years
Working time	12H(optional) 2--3 rainy days	12H(optional) 2--3 rainy days
Lifetime	30000H	30000H



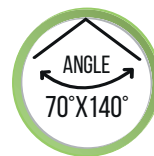
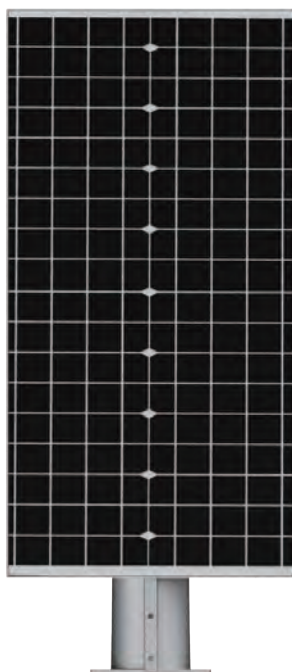

Model Number	YX-SS-01	YX-SS-01
Power	200W	300W
Battery type	LFP 32650 3.2V 15000mAh	LFP 32650 3.2V 25000mAh
Solar panel	5V 18W Monocrystalline	5V 28W Monocrystalline
Working pattern	light control + remote control + time control	
Beam Angle	70°* 140°	70°* 140°
Material	Die-casting Alu+PC/Glass	
CCT	6000-6500K	6000-6500K
Warranty	3 years	
Working time	2-3 rainy days	
Lifetime	30000H	
Size	256x588x54mm	



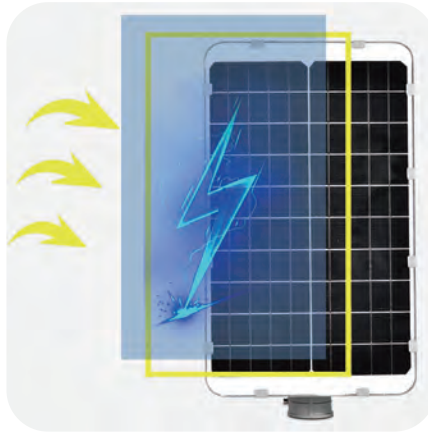

A++ Solar Board



Time control +Sensor

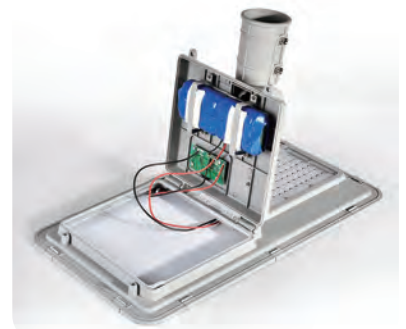

Famous brand Battery



Automatic daytime charging

Automatic lights at night

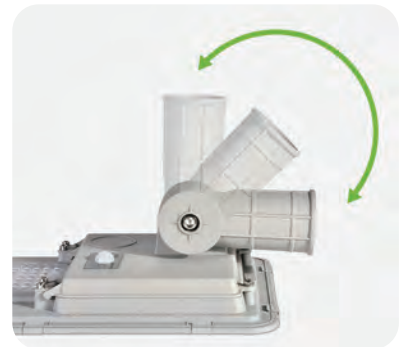

90° Rotatable

Model Number	Power	Solar Panel Power	Battery Capacity	Luminous flux (±10%)	Color Temp.	C.R.I.	IP	Size
YX-SL-04-SS	100W	14W	12000mAh	120lm/w	6000K-6500K	>70	IK08/IP65	550x288x130mm
YX-SL-04-SS	200W	24W	20000mAh	130lm/w	6000K-6500K	>70	IK08/IP65	660x332x130mm
YX-SL-04-SS	300W	36W	30000mAh	130lm/w	6000K-6500K	>70	IK08/IP65	855x350x155mm



LED Production Base
Located in **Xiamen**



New LED Production Base
Located in **Zhangzhou**

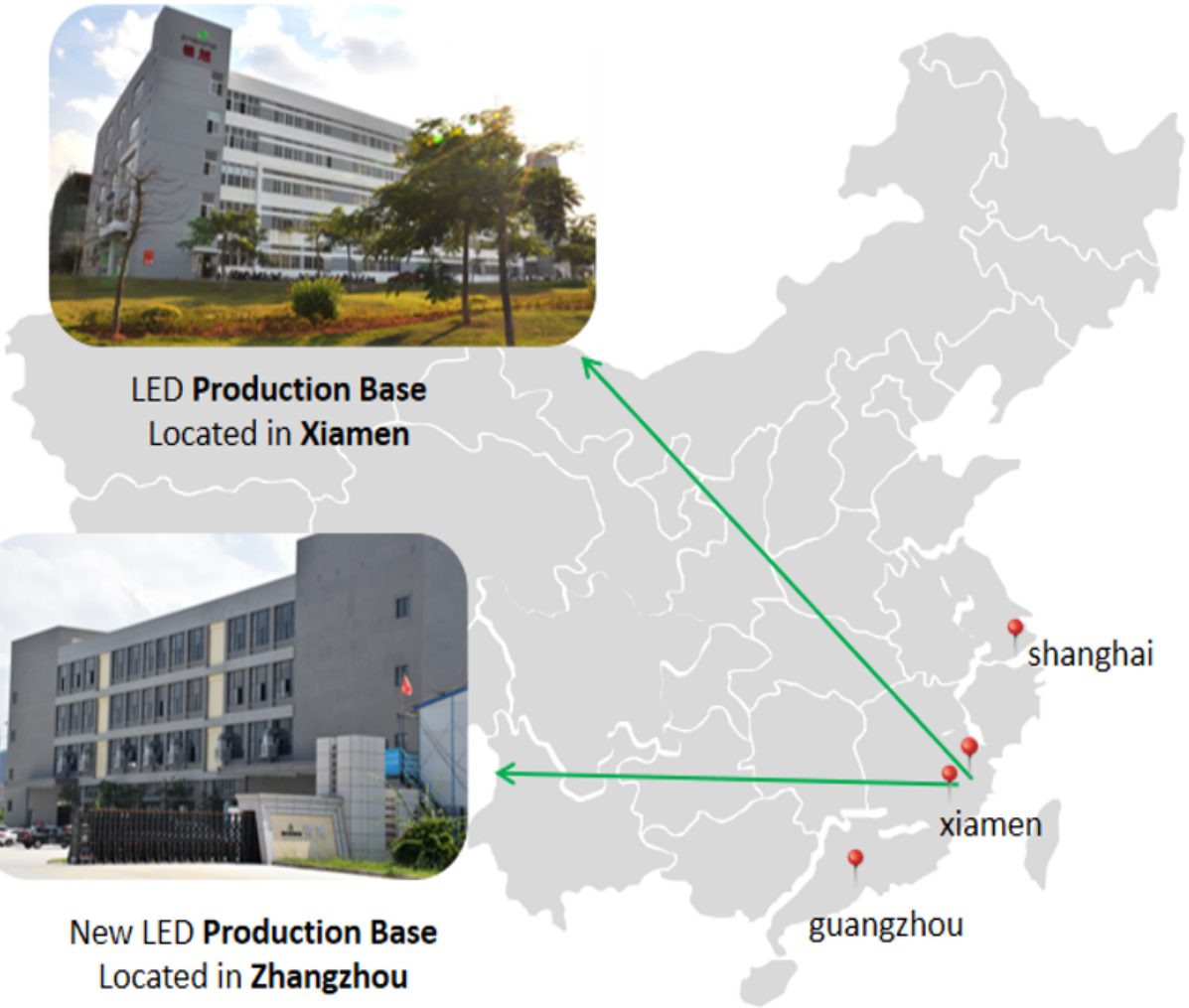

Xiamen Enshine Lighting Co., Ltd.

Enshine (Fujian) Intelligent Electric Appliance Co., Ltd.

Add: Enshine Industrial park, No.17 Zhengxing Road, Hua'an Economic Development Zone, Zhangzhou, Fujian, China

International Marketing

Tel: +86-592-5550151 Fax: +86-592-5550156

Mobile Phone: +86-18250894094

E-mail: sales206@yinxuxm.com



Wechat



Whatsapp